

bottom view

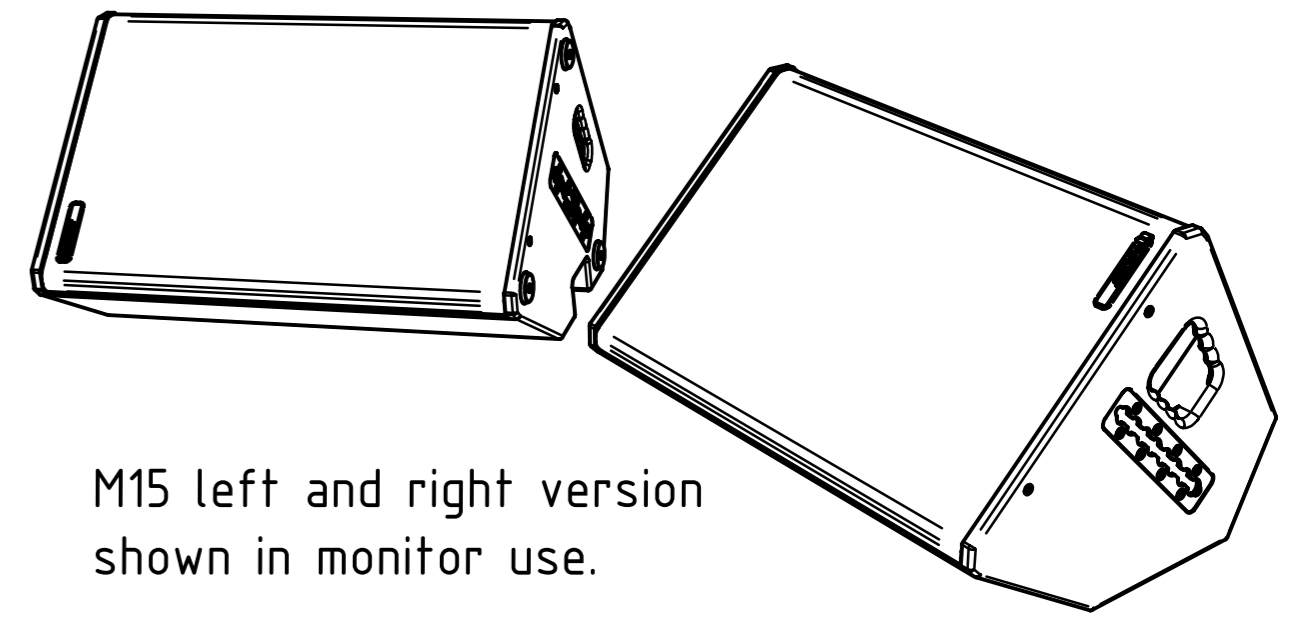

M15 left and right version shown in monitor use.

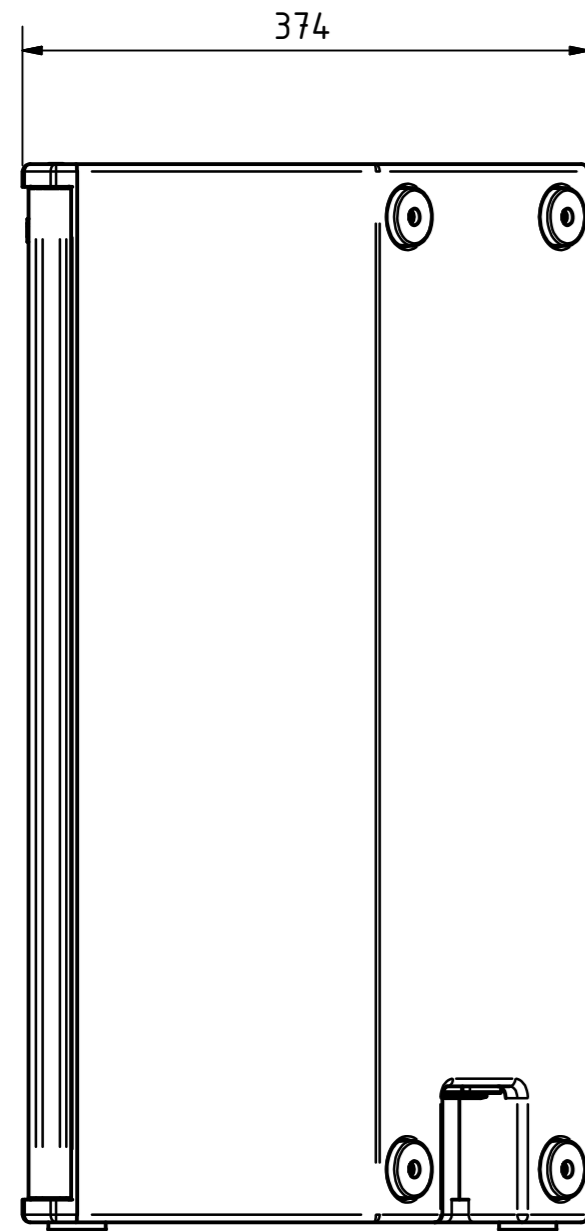

right view

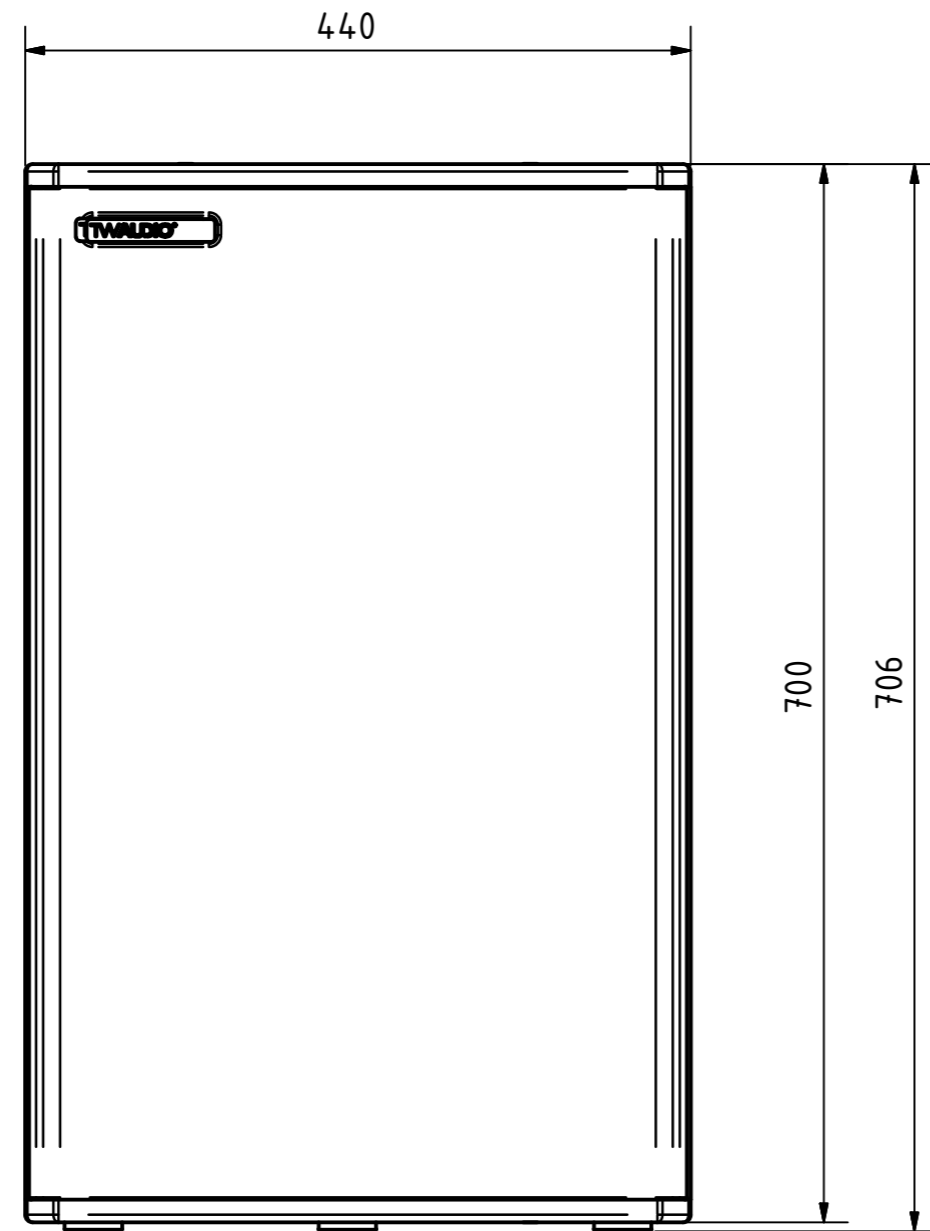

front view

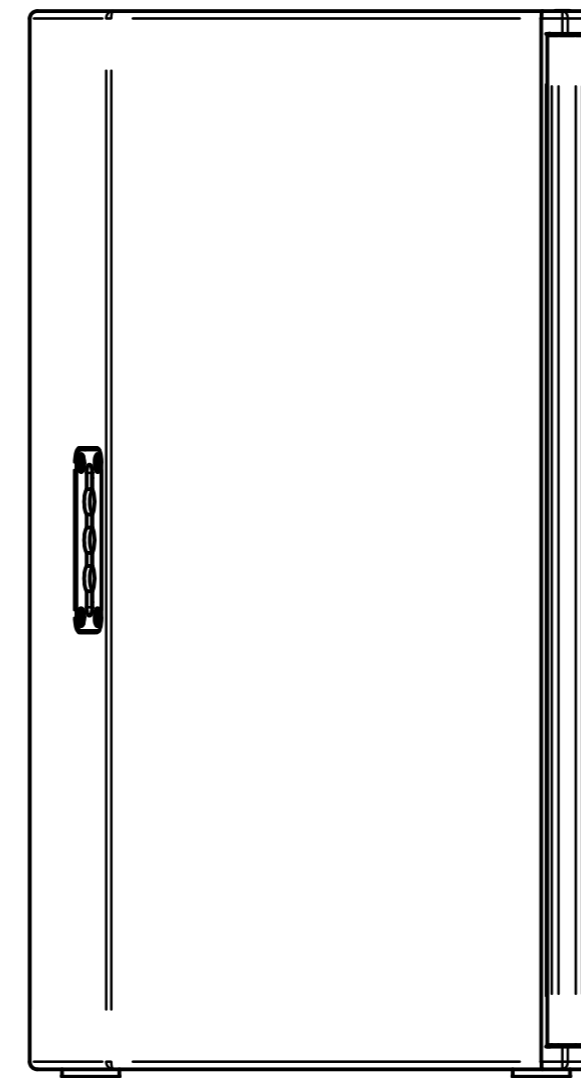

left view

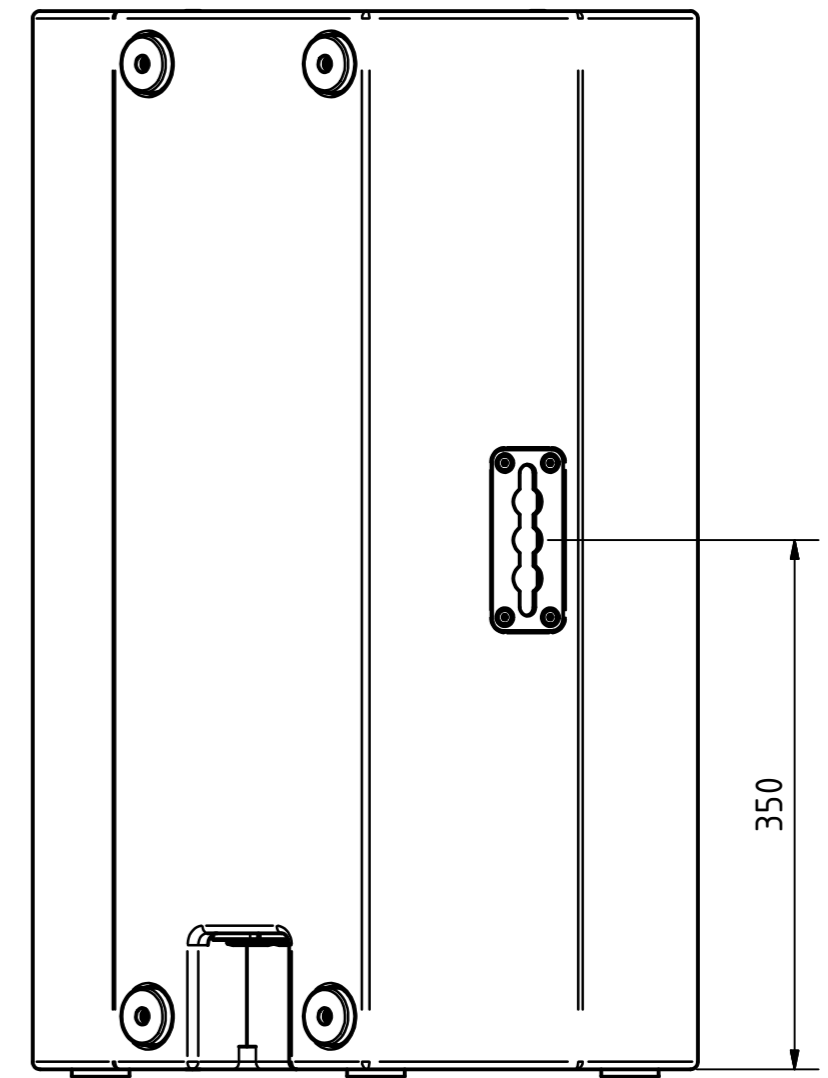

rear view

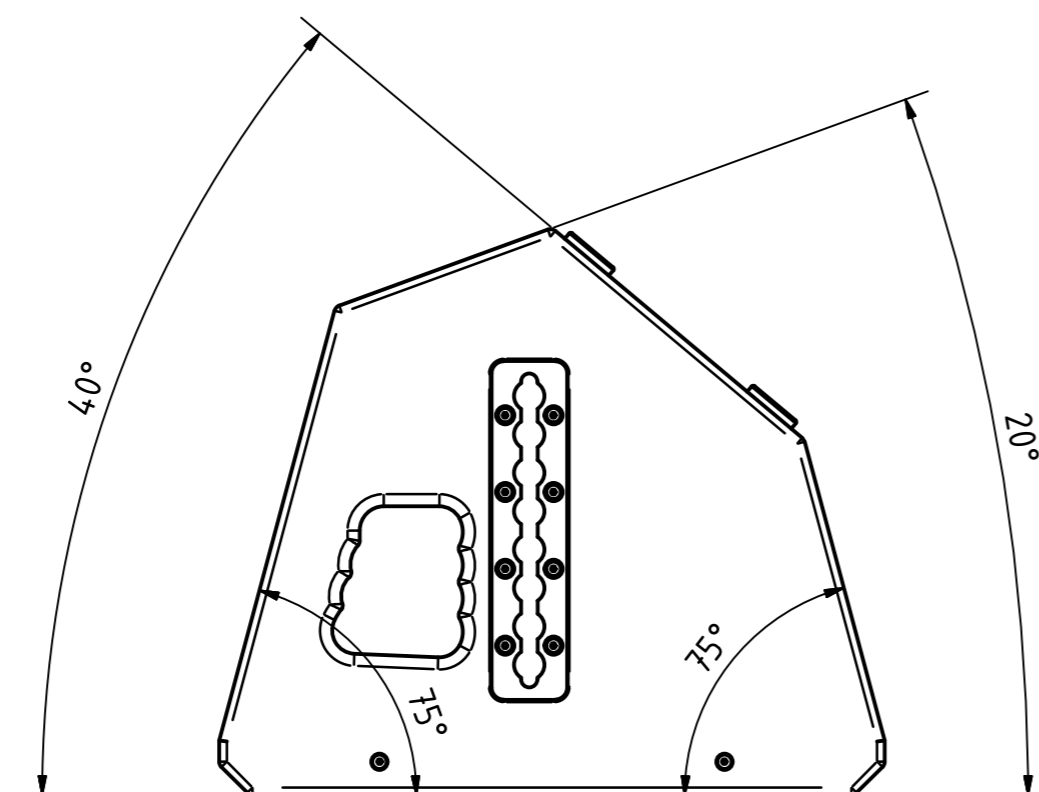
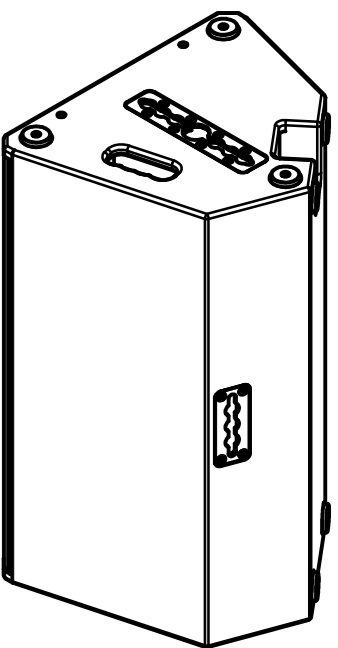

top view

0			29.10.2018	Heike Konrad
rev. no.		description	date	modified by
revision process				
TWAUDIO		scale:		
Osterholzallee 140-2 71636 Ludwigsburg www.twaudio.de		weight:	24,9kg	
All rights to this drawing reserved in accordance with ISO 16016. Copying and distribution by manufacturer's permission only.		document type:	overview drawing	
general tolerance ISO 2768-mK ISO 13920-BF ISO 9013-IIA/K according to ISO 8015		status type:	released	
edges according to ISO 13715 surfaces (Ra) array 2 array 3 DIN ISO 1302		type:	M15	
		date	name	
		18.11.2009	Stefan Ullrich	
		18.11.2009	Stefan Ullrich	
		checked:	drawing number:	
		approved:	TWA-15-0001	
		29.10.2018	Heike Konrad	
		revision no.:		sheet:
		0		1 1
				Az